

ARIZONA
TELEMEDICINE
PROGRAM



Effective Communication Etiquette Using Telehealth Technologies

Janet Major, BS

Associate Director for Innovation
and Digital Health

How to put the TELE into Telehealth for Educational & Clinical Applications



Technology
+
Telecommunications
=
Telehealth/Telemedicine

Technology
+
Telecommunications
=
Access to Healthcare

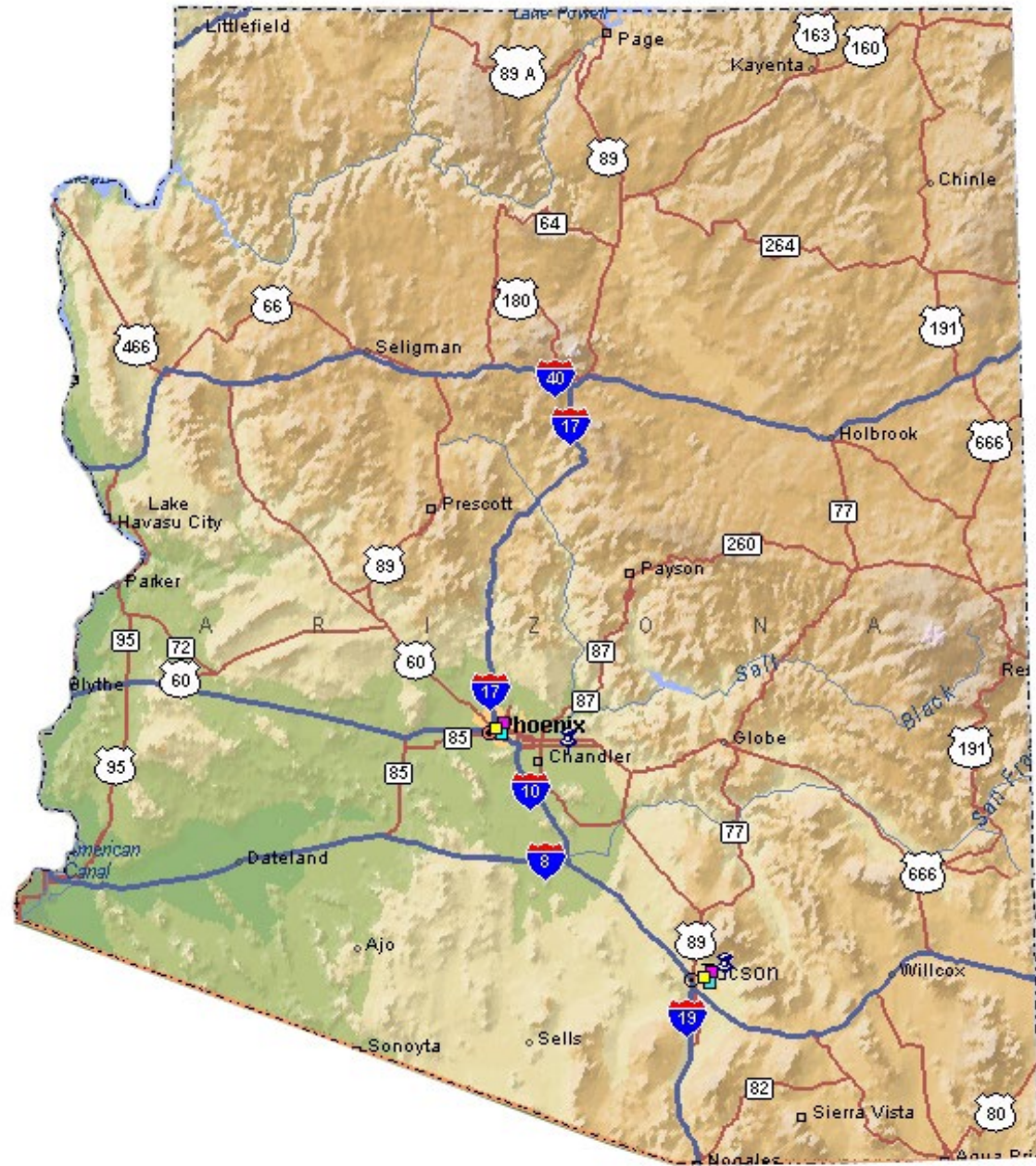

NAVAJO INDIAN RESERVATION LOCATION MAP

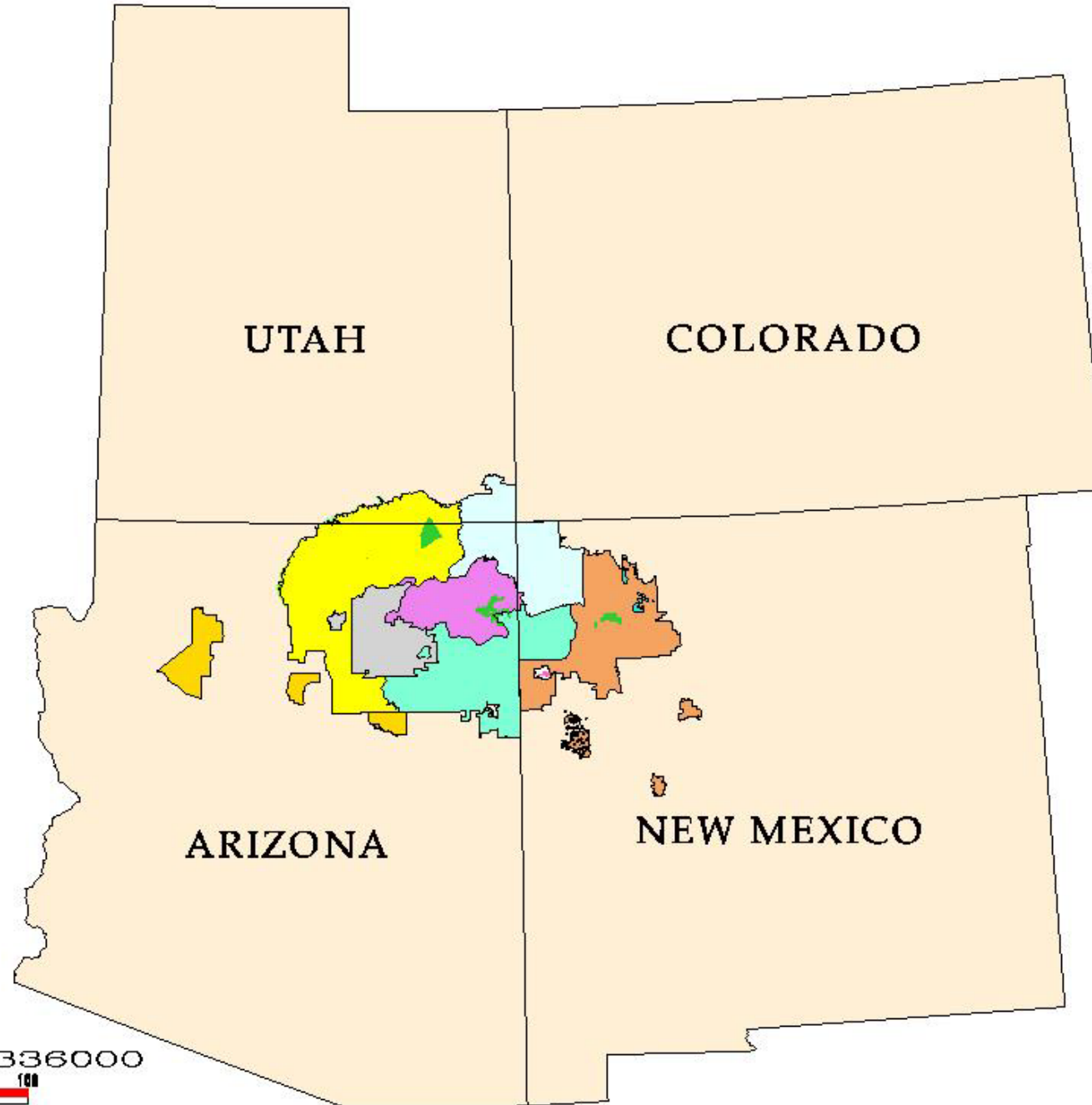

SCALE 1:6336000



February 28, 2003

NAVAJO LAND DEPARTMENT

NAVAYO NATION
SUN/PLAZA LAND DEPARTMENT
GEOGRAPHIC INFORMATION SYSTEMS SECTION
P.O. BOX 1000
TUCSON, ARIZONA 85701

<https://southwesttrc.org/> = SWTRC

Resources

Arizona

Colorado

Nevada

New Mexico

Utah



- Telemedicine & Telehealth Service Provider Directory
- Business & Finance
- Form Templates
- Policy & Sustainability
- Standards & Guidelines
- Telemedicine Information
- Tools & Tips
- General

National Consortium of Telehealth Resource Centers (NCTRC) - Find your TRC

www.telehealthresourcecenter.org



TTAC National Telehealth Technology Assessment Center telehealthtechnology.org

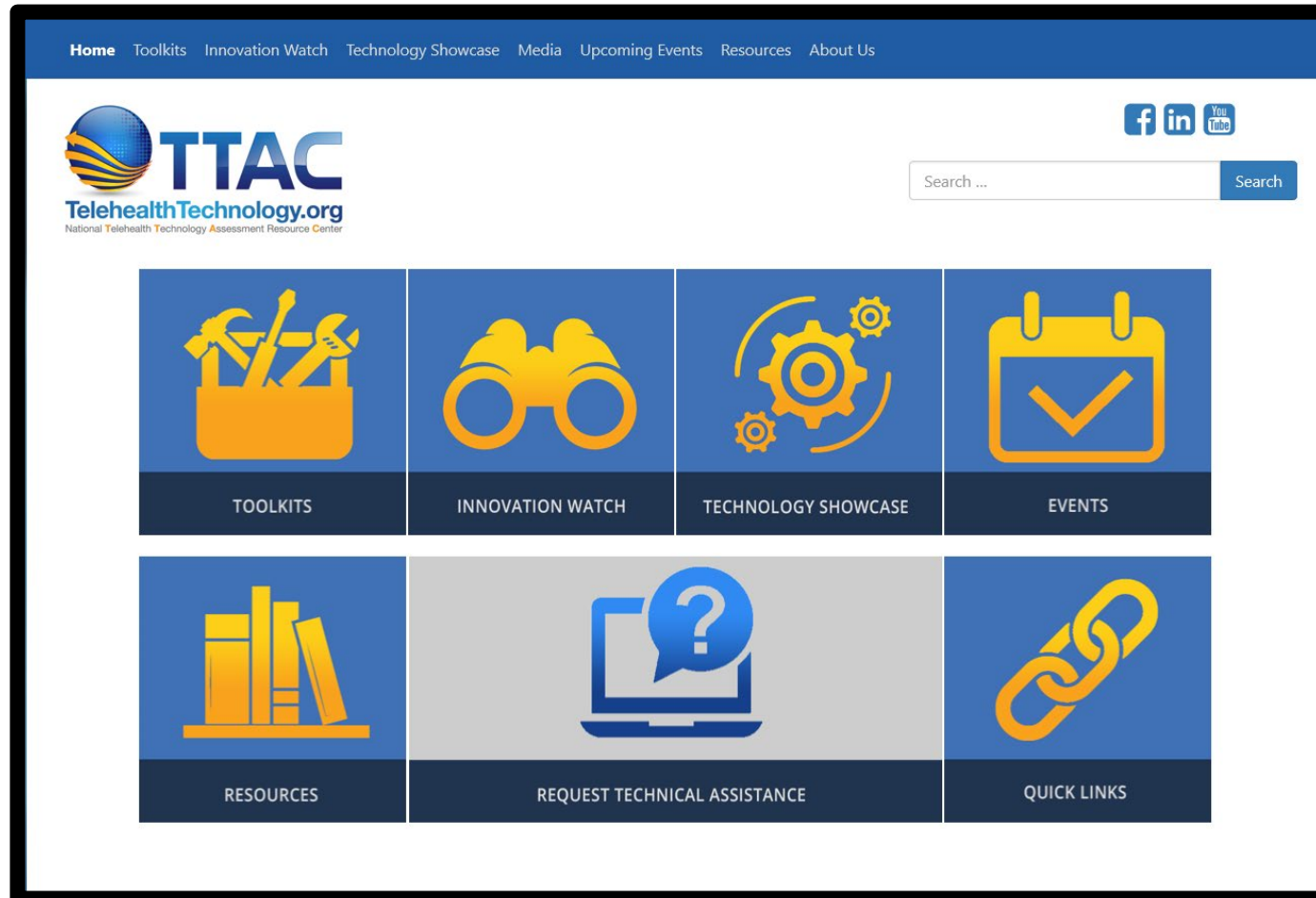

Technology for Telehealth

- Resources/where to shop
- How to shop
- Network and interview who has been doing what – with what!
- Pricing
- Ease of use/training protocols/end user
- Network support
- Contractual agreements/licenses/maintenance fees
- Efficiency?

<https://telemedicine.arizona.edu/webinars/previous>



**ARIZONA
TELEMEDICINE
PROGRAM**

Arizona Telemedicine Program

Janet Major, B.S.
Associate Director of Telemedicine
Education & Facilities
Arizona Telemedicine Program
Technical Coordinator
Southwest Telehealth Resource Center
Telehealth Board Member & President
United States Distance Learning Association
ATA mHealth, Technology & DL SIG

**SOUTHWEST
TRC
TELEHEALTH
RESOURCE CENTER**

55:13

ATA 2019 Exhibit Hall Technology Review



ARIZONA
TELEMEDICINE
PROGRAM



Telehealth Technology Resources

Arizona Telemedicine Program

www.telemedicine.arizona.edu

Telemedicine & Telehealth Service Directory

<http://telemedicine.arizona.edu/servicedirectory>

Southwest Telehealth Resource Center

www.southwesttrc.org

National Telehealth Resource Centers

www.telehealthresourcecenter.org

ATA American Telemedicine Association

www.americantelemed.org

USDLA United States Distance Learning Association

www.usdla.org

University of New Mexico Center for Telehealth

<http://hsc.unm.edu/community/telehealth/>

Project ECHO

<http://echo.unm.edu/>

ATP Project ECHO

<http://telemedicine.arizona.edu/echo/>

UNR Project ECHO

<https://med.unr.edu/echo>

TTAC Telehealth Technology Assessment

www.telehealthtechnology.org

Resource Center



A scenic view of a canyon, likely the Grand Canyon, with the word "Telepresenting" overlaid in blue text. The canyon is filled with layered rock formations and is surrounded by green trees. The sky is blue with scattered white clouds. The text is centered horizontally and vertically in the upper half of the image.

Telepresenting

Telemedicine = 

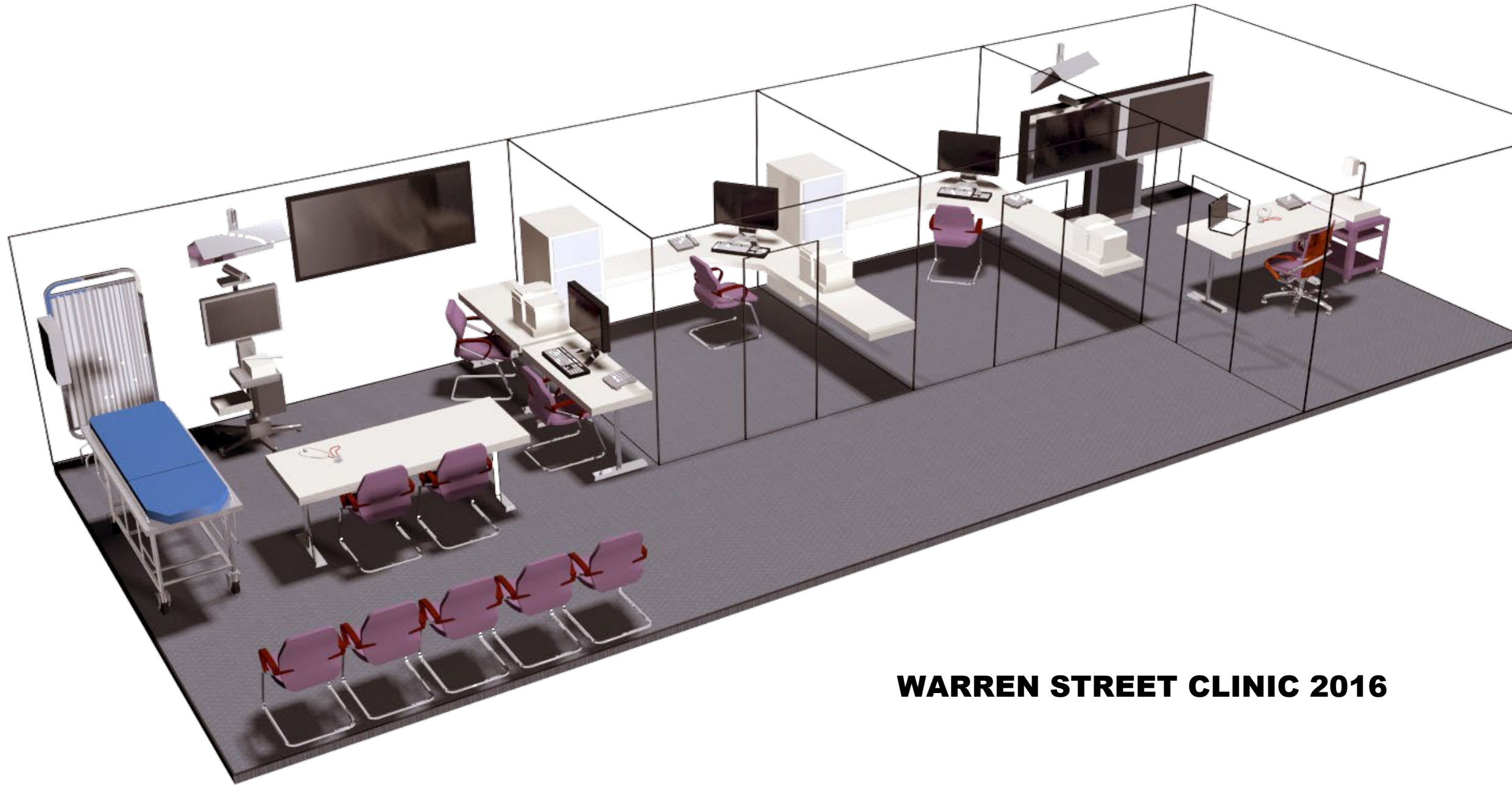

WARREN STREET CLINIC 2016

Communication Technology

- Lights, Camera ACTION!
- BACKGROUND
- Two way videoconferencing
- Web cams using secure sites over the internet
- Other devices or programs which connect to your laptop or desktop @home or bedside

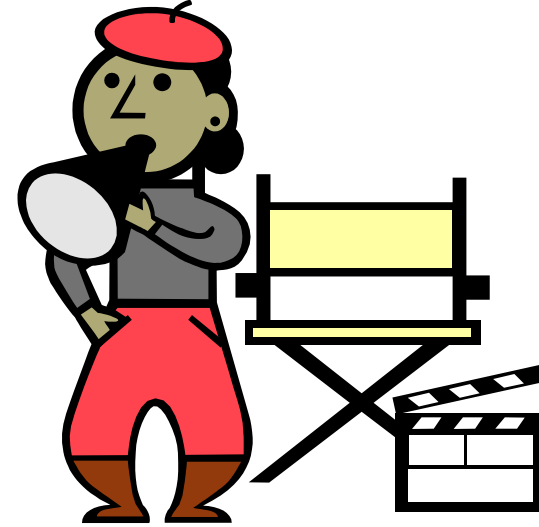

Telemedicine

- Information needs to be medically accurate
- Teaches participants to practice being good listeners as only 1 person can speak at a time
- Patient benefits from the undivided attention of a physician
- Economizes the use of time for all participants

Elements of Production

- **Sound**
 - microphones
 - electronic stethoscope
- **Lighting**
 - color temperature
 - angle
- **Space and geography of the room**

- **Same Elements of production whether you are in a state-of-the-art videoconferencing suite, using a videophone or a webcam @ your desktop!**
- **Background**
- **Lighting**
- **Audio**
- **Camera skills – be sure you are looking GOOD!**

ARIZONA
TELEMEDICINE
PROGRAM



telemedicine
=
medicine at a distance

ARIZONA TELEMEDICINE PROGRAM



Telehealth

Telehealth is sometimes discussed interchangeably with telemedicine. The [Health Resources and Services Administration](#) distinguishes telehealth from telemedicine in its scope. According to them, telemedicine only describes remote clinical services; such as diagnosis and monitoring, while telehealth includes preventative, promotive and curative care delivery. This includes the above-mentioned non-clinical applications like administration and provider education which make telehealth the preferred modern terminology.

Robots for Education







Recording

Future Telehealth Will

- Transform & empower - telehealth & digital technology will permeate all aspects healthcare – clinical, administrative, financial – including self care
- Advance & improve clinical decision support systems
- Facilitate remote patient monitoring & self care, provide ready access to your own electronic health records, improve wearable monitors & alerts
- Allow triaging, prioritizing (patients, rooms, devices etc.), diverting
- Require new workflows, operating procedures & training

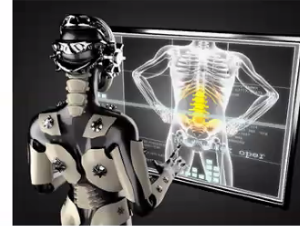
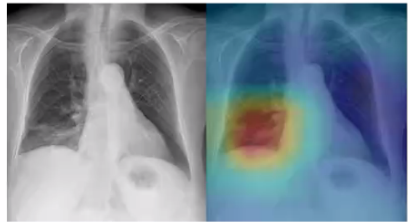

Sells IHS, AZ

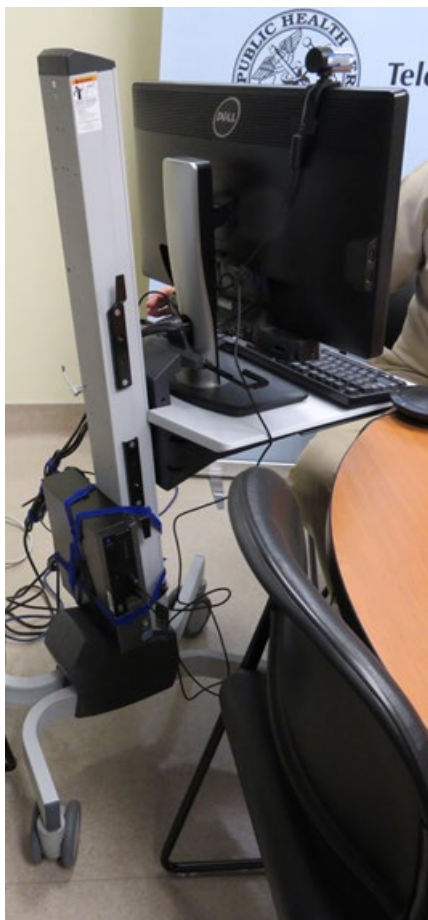



A word cloud of video conferencing software names. The words are arranged in a roughly rectangular shape, with some overlapping. The colors used are red, green, and blue. The words include: Vidyo (green), Google Hangout (red), Adobe Connect (green), Skype (red), WebEx (green), Blackboard (red), Elluminate (green), RealPresence (blue), Windows (red), ZOOM (blue), Go To Meeting (red), LIVE (green), and Bluejeans (red).

Vidyo
Google Hangout
Adobe Connect
Skype
WebEx
Blackboard
Elluminate
RealPresence
Windows
ZOOM
Go To Meeting
LIVE
Bluejeans

HIPAA Health Insurance Portability And Accountability Act of 1996



To be a good telepresenter you must be a good communicator.

- **verbally**
- **non-verbally**

SELFIES!







7 DAY FORECAST

FIRST ALERT

ON

MON	TUE	WED	THU	FRI	SAT
101	100				
71	68	67	67		

YUMA 68/103

TOMBSTONE 55/88

SUNDAY

60/91

61/93

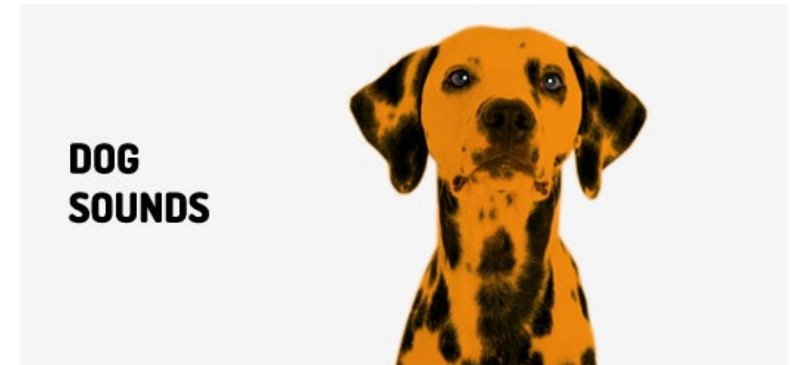

Background for Video
Background Audio - Dogs Barking, Children, SO's

**MY WIFE ASKED ME WHY I
SPOKE SO SOFTLY IN THE
HOUSE.**

**I SAID I WAS AFRAID
MARK ZUCKERBERG WAS
LISTENING!**

SHE LAUGHED.

I LAUGHED.

ALEXA LAUGHED.

SIRI LAUGHED.

Teleconferencing Tips

- wear appropriate clothing and jewelry
- be aware of your body language
- use an agenda and facilitate introductions
- develop protocols for questions
- be familiar with the equipment
- test all equipment and network connectivity in advance
- connect with remote sites at least 15 minutes early

Telehealth Best Practices



Telehealth Best Practices

Video developed by the Hawaii Department of Health Genomics Section and available on the Pacific Basin TRC Website www.pbtrc.org

Best Practices

- **Technical Protocols**
- **Clinical Protocols**
- **Mock Patients**
- **Training**

Technology



- **Makes the world a smaller place**
- **Keeps people in their communities**



Telehealth Networking

<https://echo.unm.edu/> ECHO=Extension for Community Healthcare Outcomes

Project ECHO: A Revolution in Medical Education and Care Delivery

Project ECHO is a lifelong learning and guided practice model that revolutionizes medical education and exponentially increases workforce capacity to provide best-practice specialty care and reduce health disparities. The heart of the ECHO model™ is its hub-and-spoke knowledge-sharing networks, led by expert teams who use multi-point videoconferencing to conduct virtual clinics with community providers. In this way, primary care doctors, nurses, and other clinicians learn to provide excellent specialty care to patients in their own communities.



People need access to specialty care for their complex health conditions.



There aren't enough specialists to treat everyone who needs care, especially in rural and underserved communities.



ECHO trains primary care clinicians to provide specialty care services. This means more people can get the care they need.



Patients get the right care, in the right place, at the right time. This improves outcomes and reduces costs.



Project ECHO Hubs (Global)

Hub Locations



ECHO Countries	ECHO Hubs	ECHO Programs
34	253	574

Search for Hubs & Programs

Filter by Area(s) of Focus

- Ambulatory Care
- Autism
- Behavioral/Mental Health
- Business
- Cancer
- Cancer Diagnosis
- Cancer Prevention & Risk Reduction
- Cancer Screening
- Cancer Survivorship

Filter by Hub Country

 [Clear All](#)

ECHO Hub	Program Name	Area(s) of Focus	Email	Website	Hub City	Hub St./Pr./Reg.	Hub Country
National Center for Tuberculosis and Lung Diseases	Tuberculosis/TB	Infectious Disease, Tuberculosis	✉	🌐	Tbilisi	Tbilisi	Georgia

Telerheumatology ECHO



NeoECHO



Clinical Case Presentation

SOUTHWEST TRC TELEHEALTH RESOURCE CENTER™

Home About Us People Resources Online Education Events Partners Links Help Desk Blog

Our History. Our Mission

The Southwest Telehealth Resource Center was established through a federal grant (#G221T16262) to advance telemedicine services throughout the Southwest. It is one of the largest telehealth programs in the United States, each serving a distinct geographic region. The SWTRC serves hospitals, clinics, public health offices, and other providers in the broader Southwest region.

The SWTRC assists start-up telehealth programs and serves as a resource for existing programs regarding changes in technology and other issues affecting telehealth in the Southwest region.

Telemedicine has been shown empirically to improve access to quality medical care for many patients living in rural and medically underserved areas. The SWTRC draws expertise from the internationally recognized [Arizona Telemedicine Program](#), which has been providing telemedicine services throughout the state of Arizona since 1996.

This website has been made possible by grant G22RH24279 from the Office for the Advancement of Telehealth, Federal Office of Rural Health Policy, Health Resources and Services Administration, DHHS

Key Contacts

Elizabeth A. Krupinski, PhD
Program Director
520.626.4498
[Email](#)

Kristine A. Erps
Administrative Director
520.626.2493
Toll Free: 1.877.535.6166
[Email](#)

SWTRC Services

- Full-Day Training Program
- Online Learning Modules
- Help Desk
- Technical Assistance
- Tools & Templates
- Program Development
- Business Models
- Evaluation
- Best Practices
- Clinical Operations
- Sustainability
- Equipment Recommendations
- Program Operations

Search

Arabic
English
French
Mandarin
Navajo
Spanish

Find us on Facebook

SWTRC BLOG

SPS Telemedicine Telehealth Service Provider Showcase

Service Provider Telemedicine & Telehealth

ARIZONA
TELEMEDICINE
PROGRAM

The Telemedicine Referral Case Process

Phyllis Webster,
Program Coordinator, Sr.
Arizona Telemedicine Program

© 2014 UA BOARD OF REGENTS

Case Management

Go through the steps required to set up, carry out and complete a clinical telemedicine referral.



Telemedicine Case Coordinator

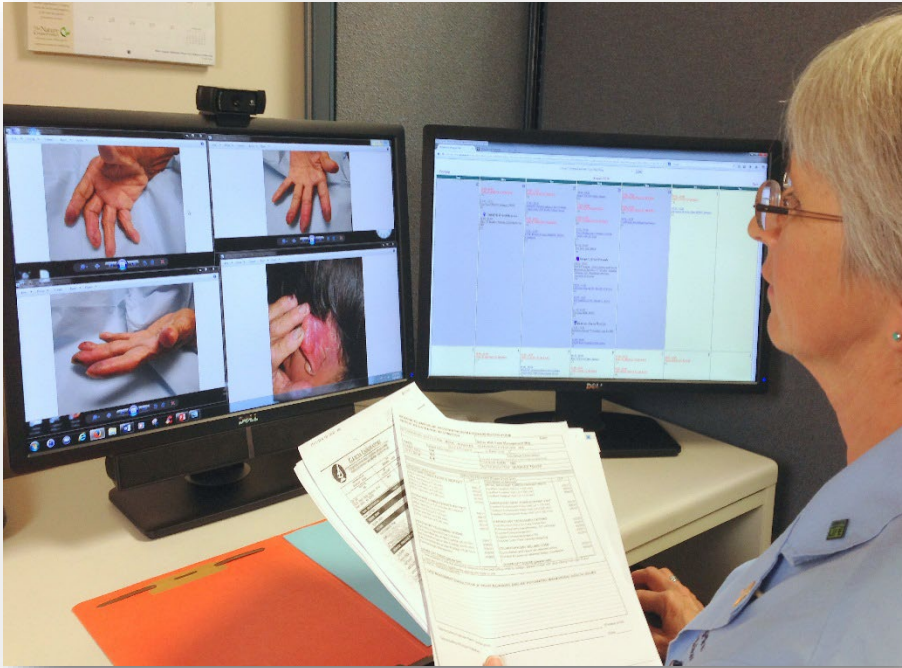

- Receives the case information and records the teleconsultation request
- Compiles and inspects demographic and clinical case information (administrative review)

Telemedicine Case Coordinator

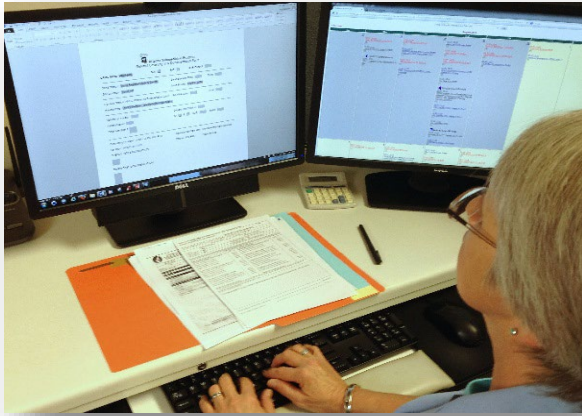

- Registers the patient
- Begins referral case processing and documentation
- Notifies Medical Director of request

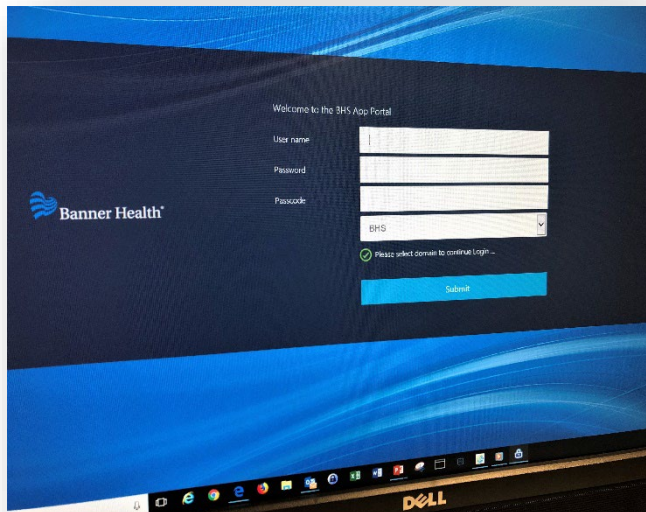

Ex: Poor diagnostic quality digital images for teledermatology referral case review 😞



Using an online calendar to schedule network activities

WebcastAHSC - Ariz

ARIZONA TELEMEDICINE PROGRAM

Arizona Telemedicine Program Events Calendar

Search | iCal / RSS | Share | Print | Help | Login

◀ September 2018 ▶

Today | Go to Date

Select Category
Select one or more... | Go | Month | Week | Day | List

Sunday	Monday	Tuesday	Wednesday	Thursday	Friday	Saturday
						1
2	3 Labor Day	4	5 ● Surgery Grand Rounds 8:00am - 9:00am ● Medicine Grand Rounds (YRMC) 12:00pm - 1:00pm ● CANCELLED -- Psychiatry Grand Rounds 4:00pm - 5:30pm	6	7	8
9	10 ● Advances in Aging Grand Rounds 12:00pm - 1:00pm	11 ● Nursing Grand Rounds 12:00pm - 1:00pm @ Drachman Hall A326	12 ● Surgery Grand Rounds 8:00am - 9:00am ● Medicine Grand Rounds (YRMC) 12:00pm - 1:00pm ● Psychiatry Grand Rounds 4:00pm - 5:30pm	13 ● Pediatric Grand Rounds 12:00pm - 1:00pm	14	15
16	17 ● Developing a Telemedicine Program Training _ Onsite Only	18	19 ● CANCELLED -- Surgery Grand Rounds 8:00am - 9:00am ● Medicine Grand Rounds (YRMC) 12:00pm - 1:00pm ● Psychiatry Grand Rounds 4:00pm - 5:30pm	20	21	22
23	24	25	26 ● Surgery Grand Rounds 8:00am - 9:00am ● Medicine Grand Rounds (YRMC) 12:00pm - 1:00pm ● Psychiatry Grand Rounds 4:00pm - 5:30pm	27 ● Pediatric Grand Rounds 12:00pm - 1:00pm	28	29
30						

The Telemedicine Coordinator may provide administrative and technical support during the session and is always immediately accessible if any needs or problems arise

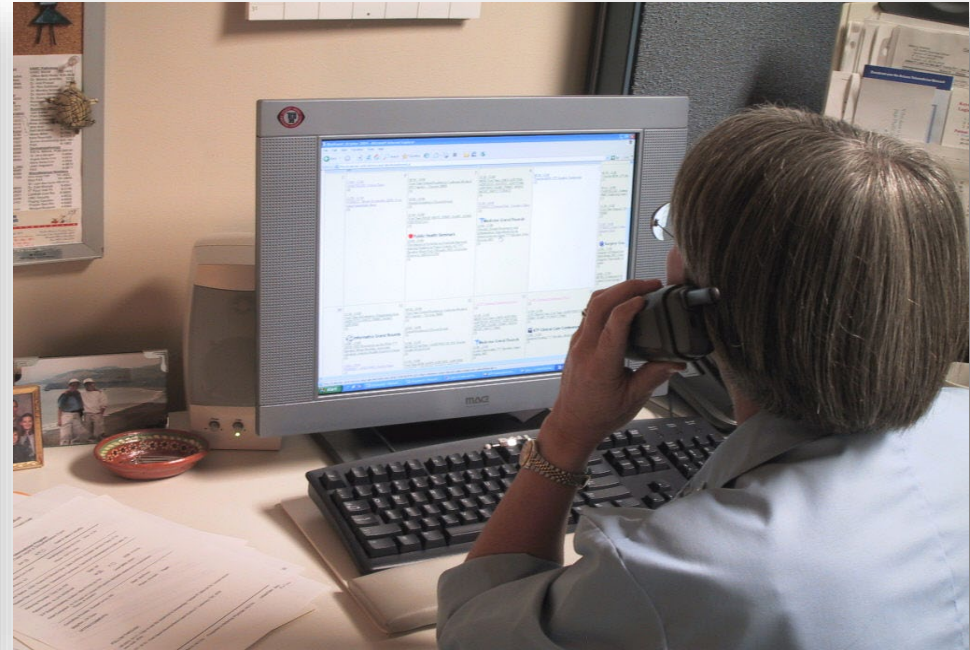
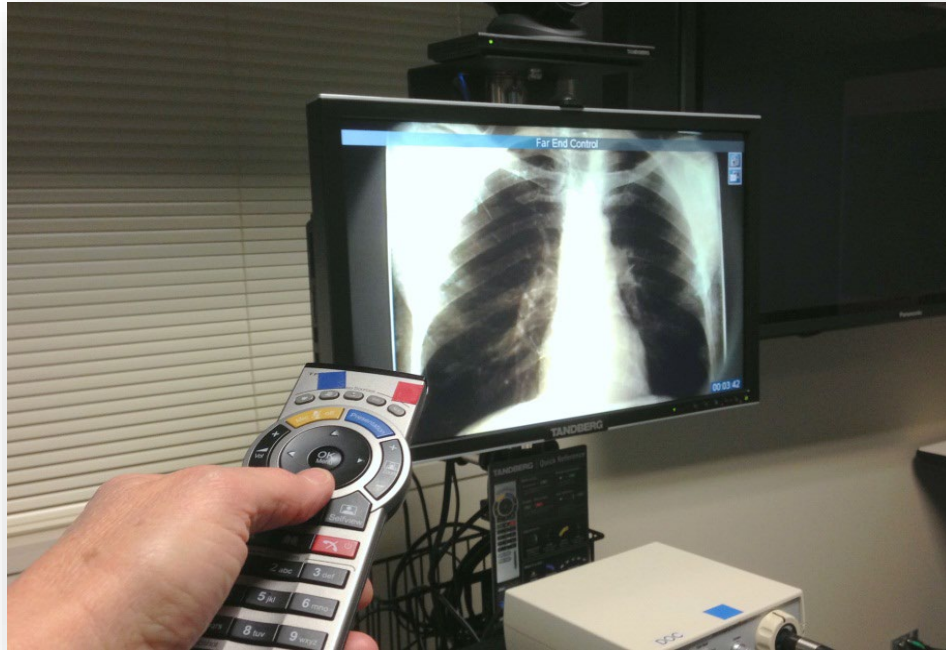

Cultural Diversity = having different cultures respect each other's differences.

- Age
- Language - ACA in Spanish, VIDA in Spanish, consent forms in Navajo, sign language and translations/interpreters
- Geography and Economy – sheep herders, copper miners
- Food – what's the best flour for making tortillas?

You can use technology to maximize the work of physicians, nurses, Certified Diabetes Educators OR Genetic Counselors in your state!



<https://azahec.uahs.arizona.edu/>

AHEC Regional Centers



ARIZONA AREA HEALTH EDUCATION CENTERS SYSTEM

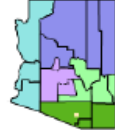

Arizona AHEC Program Office
 1834 E. Mabel Street
 Tucson, AZ 85721-0425
 (520) 626-0265
 Fax: (520) 626-4037

Director: Leila Barraza
 lbarraza@arizona.edu
Associate Director: Jennifer Zuniga
 jzuniga@arizona.edu
 Contact: Colleen Reed, Program
 Coordinator, Senior
 colleen@email.arizona.edu

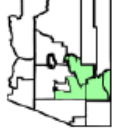

Eastern Arizona AHEC (EAHEC)
 5880 S. Hospital Drive, Suite 115
 Globe, AZ 85501-9449
 (Mailing) PO Box 572, 85502
 (928) 402-8054

Executive Director: Jeri Byrne
 jbyrne@easternazahec.net

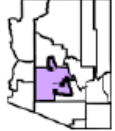

Central Arizona AHEC (CAAHEC)
 700 E. Jefferson St. Ste 100
 Phoenix, AZ 85034
 (602) 253-0090

Center Director: Ana Roscetti
 anaroscetti@yahoo.com

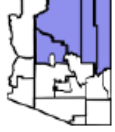

**Colorado Plateau Center for
 Health Professionals (CPCHP)**
 c/o North Country HealthCare
 2920 North Fourth Street
 Flagstaff, AZ 86004-1816
 (Mailing) PO Box 3630, 86003
 (928) 522-9855

Center Director: Marica Martinic
 mmartinic@ndhcaz.org



**Southern Arizona AHEC
 (SAAHEC)**
 450 W. Paseo Redondo
 Tucson, AZ 85701

Director: Dr. Felipe Perez
 felipep@elrio.org

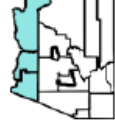

Western Arizona AHEC (WAHEC)
 950-A E. Main Street
 Somerton, AZ 85350
 (Mailing) PO Box 617 Somerton,
 85350
 (928) 315-7600

Center Director: Joena Ezroj
 jezroj@rcfbh.org



GENETICS

This is how it works.

fakeposters.com

Telegenetics

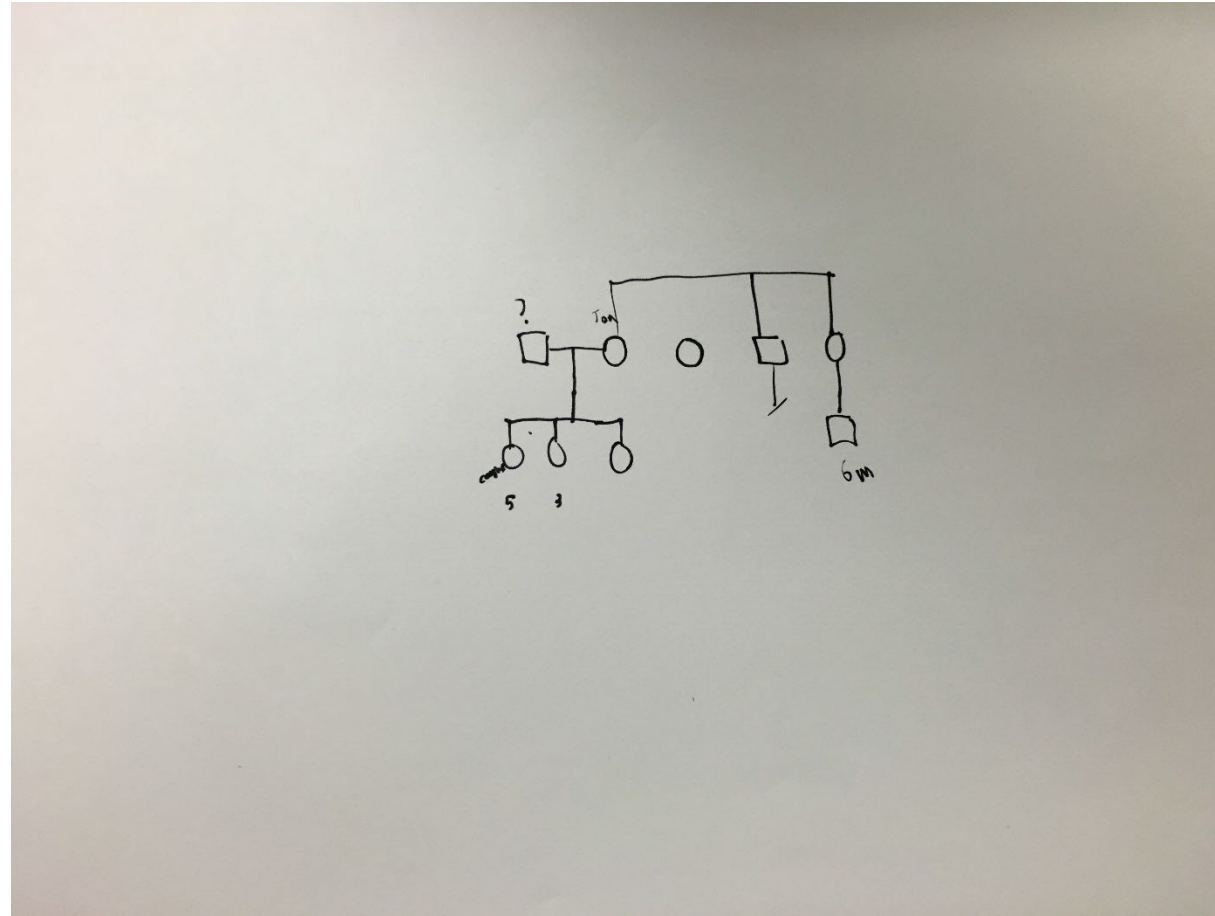

Web **Images** Videos Maps News Explore

Image size Color Type Layout People Date License SafeSearch: **Moderate**

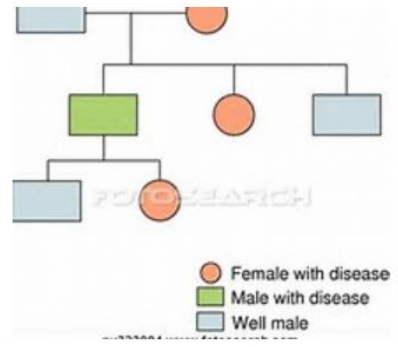
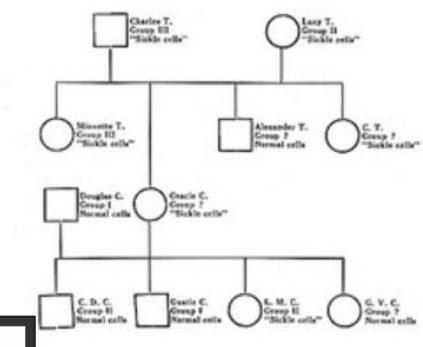
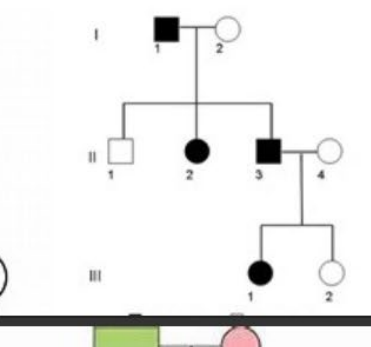
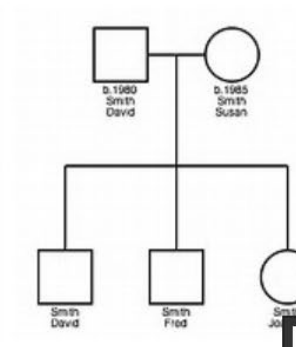
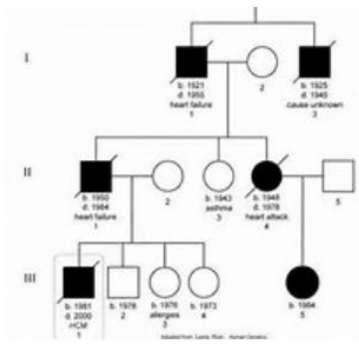

	Male	Female	Sex unknown or unspecified
Unaffected person	□	○	◇
Person affected with trait	■	●	◆
Multiple persons (5)	⑤	⑤	⑤
Deceased person	☒	☉	☎
Proband (first affected family member coming to attention of geneticist)	■	●	◆
Family history of person unknown	☐	☉	☎
Family—parents and three children: one boy and two girls in birth order			
	Identical, Nonidentical, Unknown		

ICONS SET
GREAT QUALITY SYMBOLS

CanStock

© Can Stock Photo - csp28029607

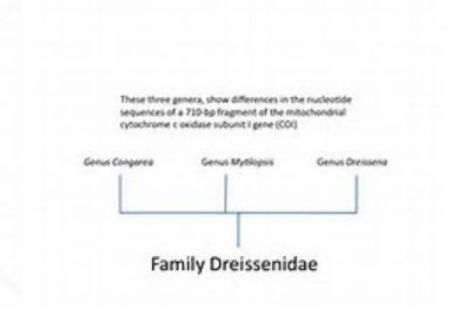
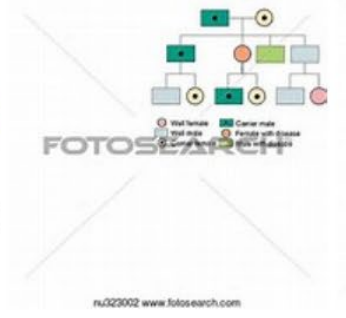
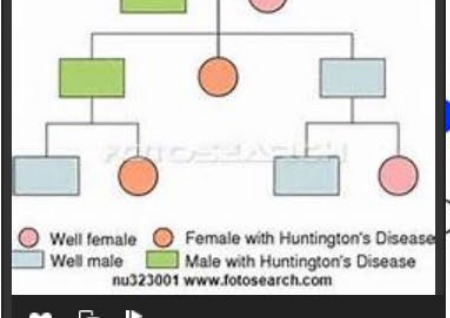



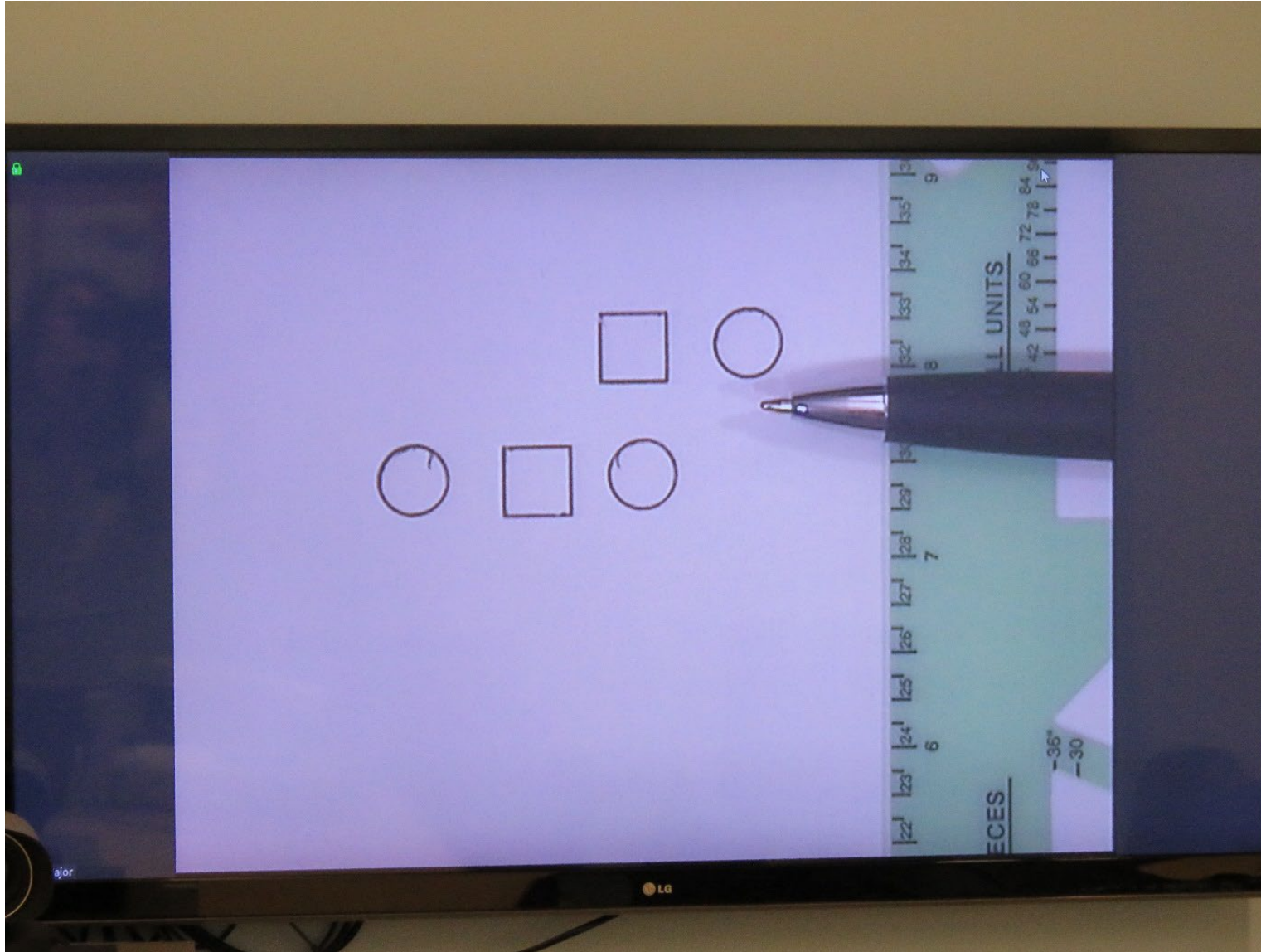

Hands-on!



The Story of Eli Coli



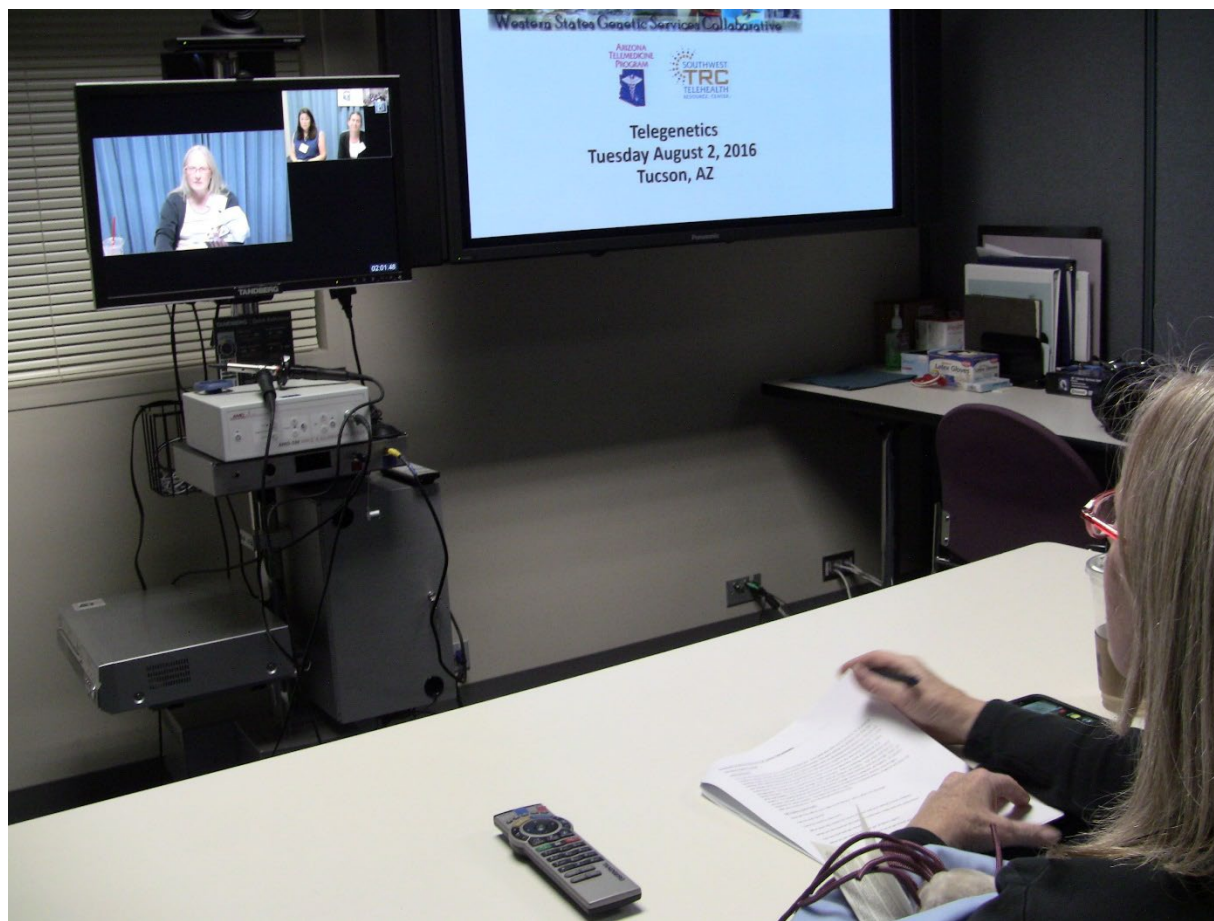



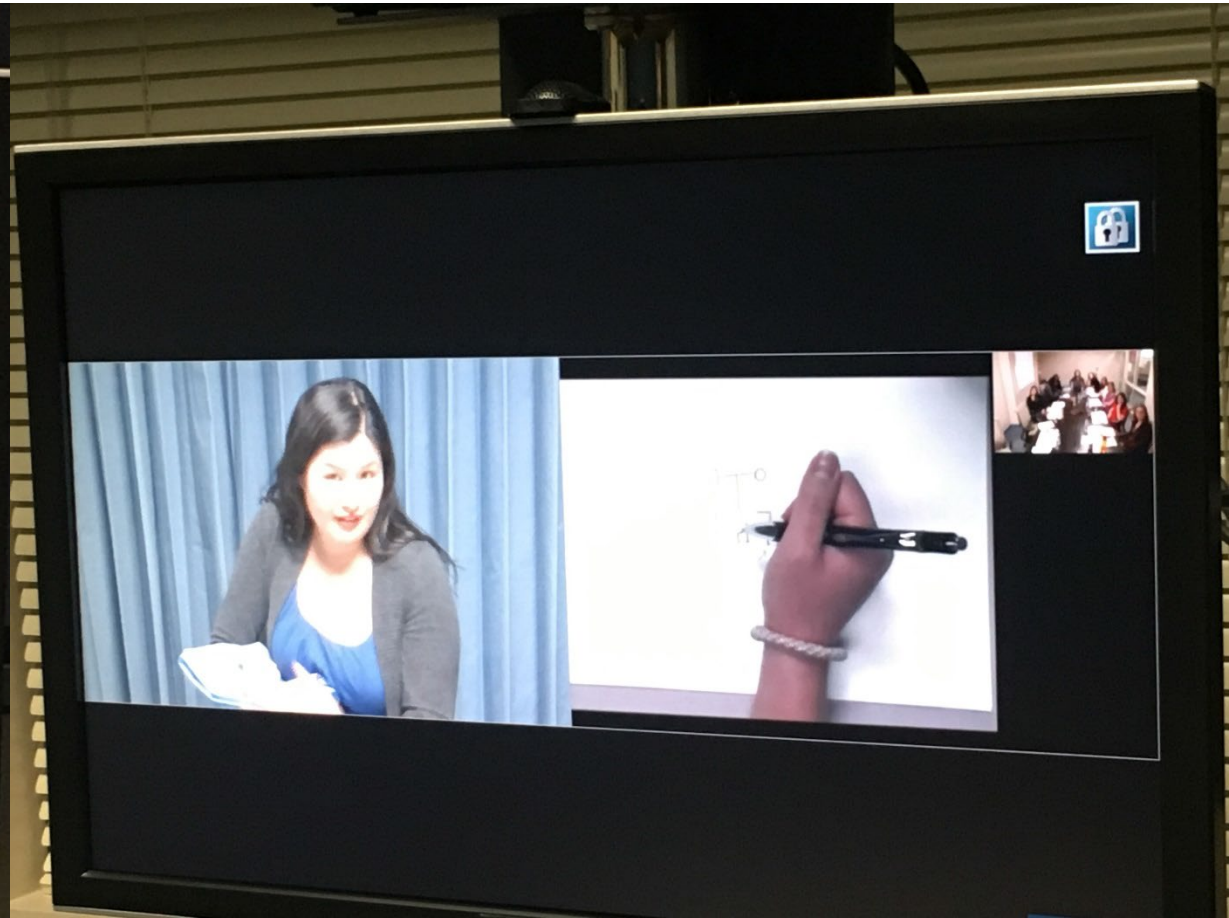





To be a good telepresenter you must be a good communicator.

- verbally
- non-verbally

Educational Materials

- send in advance whenever possible
- suggest powerpoint from a computer
- use 24 point font or greater
- use fonts like Arial or Times New Roman
- use a medium blue background with white or yellow font (high contrast)
- use a document camera for 3-D objects
- don't use red font

Chinese Interpreter Demo





Patient

Provider

Interpreter

Video Interpretation Demo

https://aztelemedicine.zoom.us/recording/play/XIB8_ixW8XffKfWS3XsI7zG6kSdMo67oSYo1NZZMGoZgzHlBjUkak4HZYvuAx5IO?continueMode=true

Technology Demo

- How to ZOOM or best use the platform you are using
- Second Camera/Document Camera
- Drawing the family pedigree

The Future is NOW!

The Jetsons - more accurate than expected



Accessibility

7,990,000 Results Any time Open links in new tab

Dictionary Powered by Oxford Languages · Bing Translator

Enter a word Look it up

ac·ces·si·bil·i·ty
[əkˌsɛsəˈbɪlədē]

NOUN

the quality of being able to be reached or entered:
"the restoration project involved repairing the roof and improving accessibility"
synonyms: ease of access · availability · approachability · obtainability · nearness · convenience · handiness · readiness · attainability · reachability

- the quality of being easy to obtain or use:
"students were concerned about the accessibility of quality academic counseling"
- the quality of being easily understood or appreciated:
"the accessibility of his work helped to popularize modern art"
synonyms: comprehensibility · intelligibility · understandability · penetrability · approachability
- the quality of being easily reached, entered, or used by people who have a disability:
"many architects believe that accommodating wheelchairs is all there is to providing accessibility"

See more definition



Accessibility

Accessibility is the design of products, devices, services, vehicles, or environments so as to be usable by people with disabilities. The concept of accessible design and practice of accessible development ensures both "direct access" (i.e. unassisted) and "indirect access" meaning compatibility with a person's assistive technology (for example, computer screen readers).

Wikipedia

Academic conferences ASSETS 2012 · CYBERLAWS 2013 · ACM... +

Image: Getty Images. Data: Wikipedia
Wikipedia text under CC-BY-SA license

danke
takku Thank You
mahalo
kiitosdekuju
gracias grazie obrigado
merci koszi
dank

ARIZONA TELEMEDICINE PROGRAM



Thank You, Merci, Gracias y CIAO!
jmajor@telemedicine.arizona.edu