



ARIZONA TELEMEDICINE PROGRAM
UPDATES

APRIL 21, 2021

ARIZONA TELEMEDICINE PROGRAM



October 20, 2021

1996

2021

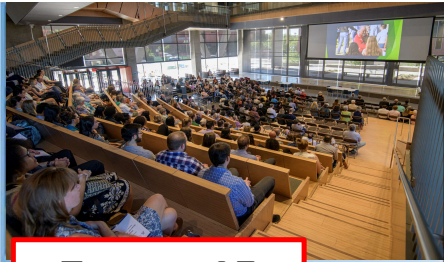

Tucson, AZ

The University Of Arizona (1996)



Arizona Telemedicine Program (1996)



Arizona Telemedicine Council (1996)



Phoenix, AZ

A

B

C

D

"Arizona Rural Telemedicine Network" (1996)

Southwest Telehealth Resource Center (2010)

Institute for Advanced Telemedicine & Telehealth "T-Health Institute" (2004)

International Telemedicine Division (Japan, China, Panama) (2000)

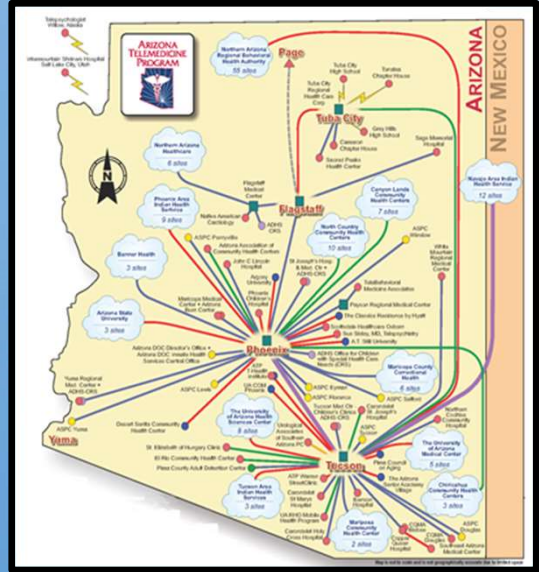

Quick Tour of the ATP's Web Pages

THE UNIVERSITY OF ARIZONA. SWTRC T-Health UAHS

ARIZONA TELEMEDICINE PROGRAM

Home **Blog** About Us Distance Education Applications & Network Resources

Telemedicine COVID-19 Resources

Blog

Reimagining the Future of Telemedicine in a Post-COVID World

Tele-Dentistry – The State of The Union

Telemedicine in the UAE: A Case Study

▶ View All Blog Posts
▶ Get Blog Updates

Events

Telehealth Rehab is so much more than just video visits (Webinar)
Apr 19, 2021 11:00am to 12:00pm MST

Arizona Telemedicine Council (Webinar)
Apr 21, 2021 11:00am to 1:00pm MST

Evaluation of the Nurtured Heart Approach To Parenting to Improve Attention and Hyperactivity/Impulsivity in Children (Webinar)
Apr 21, 2021 2:00pm to 3:00pm MST

Virtual Telehealth Office Hours
Guest: Farshad "Mazda" Shirazi, MD (Meeting)
Apr 28, 2021 12:00pm to 1:00pm MST

Virtual Telehealth Office Hours
Guest: Carol Yarbrough (Meeting)
May 19, 2021 12:00pm to 1:00pm MST

Service Provider Directory

ATP Service Desk

Telemedicine Training

AT Council





Contact Us

Southwest TRC

Get ATP/Blog Updates

enter email address

Connect With Us

Desktop Computer

12:40 AA telemedicine.arizona.edu

THE UNIVERSITY OF ARIZONA. SWTRC T-Health UAHS

ARIZONA TELEMEDICINE PROGRAM

Select a page

Telemedicine COVID-19 Resources

Events

Telehealth Rehab is so much more than just video visits (Webinar)
Apr 19, 2021 11:00am to 12:00pm MST

Arizona Telemedicine Council (Webinar)
Apr 21, 2021 11:00am to 1:00pm MST

Evaluation of the Nurtured Heart Approach To Parenting to Improve Attention and Hyperactivity/Impulsivity in Children (Webinar)
Apr 21, 2021 2:00pm to 3:00pm MST

Smart Phone

www.telemedicine.arizona.edu

THE UNIVERSITY OF ARIZONA. SWTRC T-Health UAHS

ARIZONA TELEMEDICINE PROGRAM

Home Blog About Us Distance Education Applications & Network Resources

Telemedicine COVID-19 Resources

Blog

Reimagining the Future of Telemedicine in a Post-COVID World

TheTeleDentists

Tele-Dentistry - The State of The Union

Telemedicine in the UAE: A Case Study

- View All Blog Posts
- Get Blog Updates

Events

Telehealth Rehab is so much more than just video visits (Webinar)
Apr 19, 2021 11:00am to 12:00pm MST

Arizona Telemedicine Council (Webinar)
Apr 21, 2021 11:00am to 1:00pm MST

Evaluation of the Nurtured Heart Approach To Parenting to Improve Attention and Hyperactivity/Impulsivity in Children (Webinar)
Apr 21, 2021 2:00pm to 3:00pm MST

Virtual Telehealth Office Hours
Guest: Farshad "Mazda" Shirazi, MD (Meeting)
Apr 28, 2021 12:00pm to 1:00pm MST

Virtual Telehealth Office Hours (Meeting)
Guest: Carol Yarbrough
May 19, 2021 12:00pm to 1:00pm MST

Service Provider Directory

ATP Service Desk

Telemedicine Training

AT Council

Contact Us

Southwest TRC

Get ATP/Blog Updates

enter email address

Connect With Us

f t in s

Desktop Computer

12:40 AA telemedicine.arizona.edu

THE UNIVERSITY OF ARIZONA. SWTRC T-Health UAHS

Telemedicine COVID-19 Resources

Events

Telehealth Rehab is so much more than just video visits (Webinar)
Apr 19, 2021 11:00am to 12:00pm MST

Arizona Telemedicine Council (Webinar)
Apr 21, 2021 11:00am to 1:00pm MST

Evaluation of the Nurtured Heart Approach To Parenting to Improve Attention and Hyperactivity/Impulsivity in Children (Webinar)
Apr 21, 2021 2:00pm to 3:00pm MST

Smart Phone

www.telemedicine.arizona.edu

THE UNIVERSITY OF ARIZONA. SWTRC T-Health UAHS

ARIZONA TELEMEDICINE PROGRAM

Home Blog About Us Distance Education Applications & Network Resources

Telemedicine COVID-19 Resources

Blog

Reimagining the Future of Telemedicine in a Post-COVID World

TheTeleDentists

Tele-Dentistry - The State of The Union

Telemedicine in the UAE: A Case Study

View All Blog Posts
Get Blog Updates

Events

Telehealth Rehab is so much more than just video visits (Webinar)
Apr 19, 2021 11:00am to 2:00pm MST

Arizona Telemedicine Council (Webinar)
Apr 21, 2021 11:00am to 1:00pm MST

Evaluation of the Nurtured Heart Approach To Parenting to Improve Attention and Hyperactivity/Impulsivity in Children (Webinar)
Apr 21, 2021 2:00pm to 3:00pm MST

Virtual Telehealth Office Hours
Guest: Farshad "Mazda" Shirazi, MD (Meeting)
Apr 28, 2021 12:00pm to 1:00pm MST

Virtual Telehealth Office Hours
Guest: Carol Yarbrough (Meeting)
May 19, 2021 12:00pm to 1:00pm MST

Service Provider Directory
ATP Service Desk
Telemedicine Training
AT Council
Contact Us
Southwest TRC

Get ATP/Blog Updates

enter email address

Connect With Us

f t in s

Desktop Computer

12:40 AA telemedicine.arizona.edu

THE UNIVERSITY OF ARIZONA. SWTRC T-Health UAHS

Select a page

Telemedicine COVID-19 Resources

Events

Telehealth Rehab is so much more than just video visits (Webinar)
Apr 19, 2021 11:00am to 12:00pm MST

Arizona Telemedicine Council (Webinar)
Apr 21, 2021 11:00am to 1:00pm MST

Evaluation of the Nurtured Heart Approach To Parenting to Improve Attention and Hyperactivity/Impulsivity in Children (Webinar)
Apr 21, 2021 2:00pm to 3:00pm MST

Smart Phone

www.telemedicine.arizona.edu

THE UNIVERSITY OF ARIZONA. SWTRC T-Health UAHS

ARIZONA TELEMEDICINE PROGRAM

Home **Blog** About Us Distance Education Applications & Network Resources

Telemedicine COVID-19 Resources

Blog



Reimagining the Future of Telemedicine in a Post-COVID World



The Tele Dentists

Tele-Dentistry - The State of The Union



Telemedicine in the UAE: A Case Study

- ▶ View All Blog Posts
- ▶ Get Blog Updates

Events

Telehealth Rehab is so much more than just video visits (Webinar)
Apr 19, 2021 11:00am to 12:00pm MST

Arizona Telemedicine Council (Webinar)
Apr 21, 2021 11:00am to 1:00pm MST

Evaluation of the Nurtured Heart Approach To Parenting to Improve Attention and Hyperactivity/Impulsivity in Children (Webinar)
Apr 21, 2021 2:00pm to 3:00pm MST

Virtual Telehealth Office Hours
Guest: Farshad "Mazda" Shirazi, MD (Meeting)
Apr 28, 2021 12:00pm to 1:00pm MST

Virtual Telehealth Office Hours (Meeting)
Guest: Carol Yarbrough
May 19, 2021 12:00pm to 1:00pm MST

- Service Provider Directory
- ATP Service Desk
- Telemedicine Training
- AT Council
- Contact Us
- Southwest TRC

Get ATP/Blog Updates

enter email address

Connect With Us

f t in s

12:54 AA telemedicine.arizona.edu

ARIZONA TELEMEDICINE PROGRAM

THE UNIVERSITY OF ARIZONA. SWTRC T-Health UAHS

Select a page

The Arizona Telemedicine Program Blog



Reimagining the Future of Telemedicine in a Post-COVID World

By Dr. Leo P. Langlois on Apr 08, 2021

As with any healthcare innovation that is disruptive in nature, it takes validation and time, as well as the right

< > share bookmark copy

The Arizona Telemedicine Program Blog



Reimagining the Future of Telemedicine in a Post-COVID World

By Dr. Leo P. Langlois on Apr 08, 2021

As with any healthcare innovation that is disruptive in nature, it takes validation and time, as well as the right catalyst before it gets completely embraced by the global community as a feasible solution. With the ongoing COVID-19 global health emergency, one such innovation that acquired center stage for being highly functional and transformed healthcare delivery in a never-seen-before manner was telemedicine.

Just last year, telemedicine grew from less than 1% of primary care visits to nearly 43.5% in a mere span of two months (February to April).

With telemedicine's current rapid adoption rate and trajectory, it wouldn't be wrong to say that this state-of-the-art innovation holds the potential to turn the medical industry completely upside-down, redefining the way in which health systems deliver care, operate, and manage costs. This will further set the foundation for a highly optimized and tailored healthcare experience in the future.

Blog Categories

- News & Events
- Patients
- Policy
- Providers
- Technology
- Training
- mHealth

Get ATP/Blog Updates

Connect With Us



Write for the ATP Blog

Guest Author

The Arizona Telemedicine Program Blog



Reimagining the Future of Telemedicine in a Post-COVID World

By Dr. Leo P. Langlois on Apr 08, 2021

As with any healthcare innovation that is disruptive in nature, it takes validation and time, as well as the right

The Arizona Telemedicine Program Blog

About the Author



Dr. Leo P. Langlois is an extensively experienced board certified physician and surgeon, graduated from **Brown University Medical School**, completed residency training at Walter Reed Army Medical Center and fellowship trained at University of California Davis with over 27 years of experience treating chronic disabling conditions and chronic intractable pain who has run a successful private practice in Bakersfield, California since 2003.

Reim
Wor

By Dr.

As with
time, a
comm
emerg

functional and transformed healthcare delivery in a never-seen-before manner was telemedicine.

Just last year, telemedicine grew from less than 1% of primary care visits to nearly 43.5% in a mere span of two months (February to April).

With telemedicine's current rapid adoption rate and trajectory, it wouldn't be wrong to say that this state-of-the-art innovation holds the potential to turn the medical industry completely upside-down, redefining the way in which health systems deliver care, operate, and manage costs. This will further set the foundation for a highly optimized and tailored healthcare experience in the future.

Write for the ATP Blog

Guest Author

The Arizona Telemedicine Program Blog



Reimagining the Future of Telemedicine in a Post-COVID World

By Dr. Leo P. Langlois on Apr 08, 2021

As with any healthcare innovation that is disruptive in nature, it takes validation and time, as well as the right catalyst before it gets completely embraced by the global community as a feasible solution. With the ongoing COVID-19 global health emergency, one such innovation that acquired center stage for being highly functional and transformed healthcare delivery in a never-seen-before manner was telemedicine.

Just last year, telemedicine grew from less than 1% of primary care visits to nearly 43.5% in a mere span of two months (February to April).

With telemedicine's current rapid adoption rate and trajectory, it wouldn't be wrong to say that this state-of-the-art innovation holds the potential to turn the medical industry completely upside-down, redefining the way in which health systems deliver care, operate, and manage costs. This will further set the foundation for a highly optimized and tailored healthcare experience in the future.

Blog Categories

- News & Events
- Patients
- Policy
- Providers
- Technology
- Training
- mHealth

Get ATP/Blog Updates

Connect With Us



Write for the ATP Blog

[Guest Author](#)

The Arizona Telemedicine Program Blog



Reimagining the Future of Telemedicine in a Post-COVID World

By Dr. Leo P. Langlois on Apr 08, 2021

As with any healthcare innovation that is disruptive in nature, it takes validation and time, as well as the right catalyst before it gets completely embraced by the global community as a feasible solution. With the ongoing COVID-19 global health emergency, one such innovation that acquired center stage for being highly functional and transformed healthcare delivery in a never-seen-before manner was telemedicine.

Just last year, telemedicine grew from less than 1% of primary care visits to nearly 43.5% in a mere span of two months (February to April).

With telemedicine's current rapid adoption rate and trajectory, it wouldn't be wrong to say that this state-of-the-art innovation holds the potential to turn the medical industry completely upside-down, redefining the way in which health systems deliver care, operate, and manage costs. This will further set the foundation for a highly optimized and tailored healthcare experience in the future.

Blog Categories

- News & Events
- Patients
- Policy
- Providers
- Technology
- Training
- mHealth

Get ATP/Blog Updates

enter email address

Connect With Us



Write for the ATP Blog

Guest Author

The Arizona Telemedicine Program Blog



Reimagining the Future of Telemedicine in a Post-COVID World

By Dr. Leo P. Langlois on Apr 08, 2021

As with any healthcare innovation that is disruptive in nature, it takes validation and time, as well as the right catalyst before it gets completely embraced by the global community as a feasible solution. With the ongoing COVID-19 global health emergency, one such innovation that acquired center stage for being highly functional and transformed healthcare delivery in a never-seen-before manner was telemedicine.

Just last year, telemedicine grew from less than 1% of primary care visits to nearly 43.5% in a mere span of two months (February to April).

With telemedicine's current rapid adoption rate and trajectory, it wouldn't be wrong to say that this state-of-the-art innovation holds the potential to turn the medical industry completely upside-down, redefining the way in which health systems deliver care, operate, and manage costs. This will further set the foundation for a highly optimized and tailored healthcare experience in the future.

Blog Categories

- News & Events
- Patients
- Policy
- Providers
- Technology
- Training
- mHealth

Get ATP/Blog Updates

Connect With Us



Write for the ATP Blog

[Guest Author](#)

The Arizona Telemedicine Program Blog



Reimagining the Future of Telemedicine in a Post-COVID World

By Dr. Leo P. Langlois on Apr 08, 2021

As with any healthcare innovation that is disruptive in nature, it takes validation and time, as well as the right catalyst before it gets completely embraced by the global community as a feasible solution. With the ongoing COVID-19 global health emergency, one such innovation that acquired center stage for being highly functional and transformed healthcare delivery in a never-seen-before manner was telemedicine.

Just last year, telemedicine grew from less than 1% of primary care visits to nearly 43.5% in a mere span of two months (February to April).

With telemedicine's current rapid adoption rate and trajectory, it wouldn't be wrong to say that this state-of-the-art innovation holds the potential to turn the medical industry completely upside-down, redefining the way in which health systems deliver care, operate, and manage costs. This will further set the foundation for a highly optimized and tailored healthcare experience in the future.

Blog Categories

- News & Events
- Patients
- Policy
- Providers
- Technology
- Training
- mHealth

Get ATP/Blog Updates

Connect With Us



Write for the ATP Blog

[Guest Author](#)

ARIZONA TELEMEDICINE PROGRAM



- Home
- Blog
- About Us
- Distance Education
- Applications & Network
- Resources

Telemedicine COVID-19 Resources

Blog



Reimagining the Future of Telemedicine in a Post-COVID World



Tele-Dentistry - The State of The Union



Telemedicine in the UAE: A Case Study

- ▶ View All Blog Posts
- ▶ Get Blog Updates

Events

Telehealth Rehab is so much more than just video visits (Webinar)
 Apr 19, 2021 11:00am to 12:00pm MST



Arizona Telemedicine Council (Webinar)
 Apr 21, 2021 11:00am to 1:00pm MST



Evaluation of the Nurtured Heart Approach To Parenting to Improve Attention and Hyperactivity/Impulsivity in Children (Webinar)
 Apr 21, 2021 2:00pm to 3:00pm MST



Virtual Telehealth Office Hours
 Guest: Farshad "Mazda" Shirazi, MD (Meeting)
 Apr 28, 2021 12:00pm to 1:00pm MST



Virtual Telehealth Office Hours
 Guest: Carol Yarbrough (Meeting)
 May 19, 2021 12:00pm to 1:00pm MST



Service Provider Directory

ATP Service Desk

Telemedicine Training

AT Council

Contact Us

Southwest TRC

Get ATP/Blog Updates

enter email address

Connect With Us



Categories of Telemedicine Services

Direct-to-Hospital (DTH) Services

Direct-to-Consumer (DTC) Services

Search the Directory

Company Name (or part of)

Services In

- Alabama
- Alaska
- Arizona
- Arkansas
- California
- Colorado
- Connecticut
- Delaware

Tele-services

- Addiction
- Allergy
- Audiology
- Autism
- Bariatric medicine
- Burn
- Cardiology
- Chronic disease management

Customers

- Accountable Care Organizations
- Assisted living facilities
- Community mental health clinics
- Correctional facilities
- Educational institutions
- Employers
- FQHCs
- Government agencies

Ancillary Services

- Continuing education
- Continuing medical education
- Distance education
- Health call center
- Language interpretation services

Home » Resources » Service Provider Directory

Service Provider Directory



DIRECTORY OVERVIEW

Welcome to the Telemedicine & Telehealth Service Provider Directory, a service of the Arizona Telemedicine Program. The directory is a resource for hospital and healthcare administrators and other decision-makers who want to expand or improve their healthcare services to their patients, employees, clients, etc. The directory lists companies providing medical specialty services (such as radiology, rheumatology, neurology, psychiatry) and ancillary services (such as patient education and language interpretation) through telemedicine to healthcare providers such as hospitals, clinics, nursing homes, private practices and urgent care centers.

Service Providers: List your company here.

179 record(s) found, scroll down to see results. Page 1 of 9 page(s); up to 20 displayed per page.

Directory Listings

Scroll to view company dashboard listings in alphabetical order.

Click on company name or logo to see more detailed information.

Select a page

Search the Directory

Company Name (or part of)

Services In

0 Items

Tele-services

0 Items

Customers

0 Items

Ancillary Services

0 Items

Items per page

20

Search listings

Clear search

Overview: Service Provider Directory



ARIZONA
TELEMEDICINE
PROGRAM



telemedicine.arizona.edu



Overview: Service Provider Directory

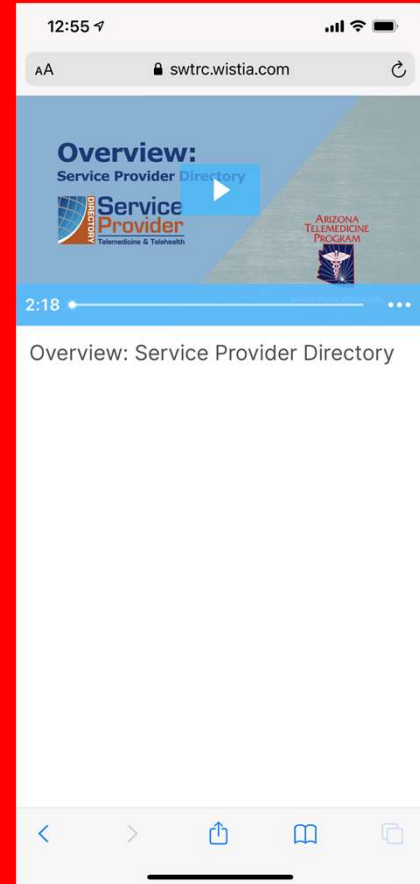



ARIZONA
TELEMEDICINE
PROGRAM



SOUTHWEST
TELEHEALTH
RESOURCE CENTER

TRC

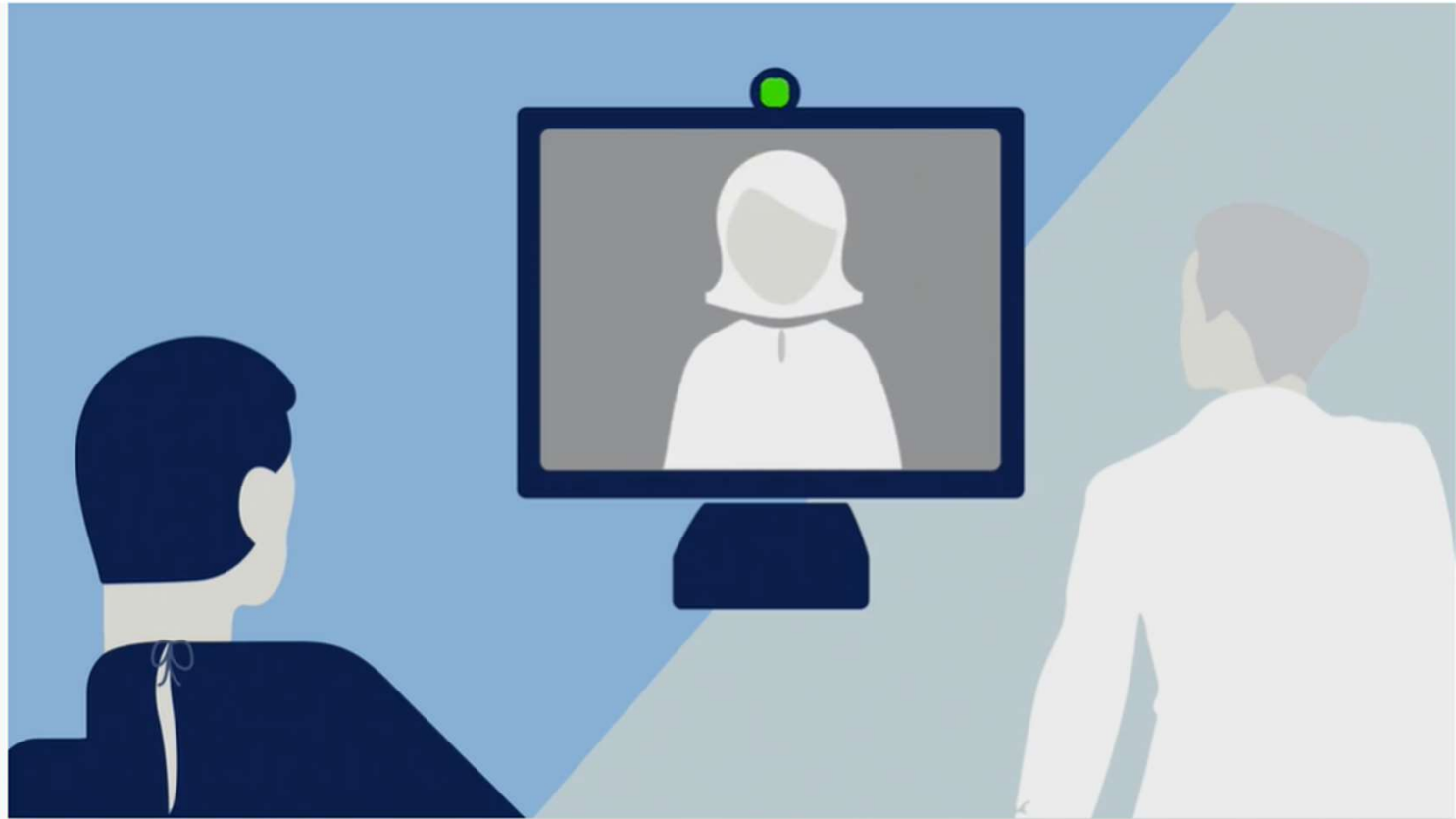

Overview: Service Provider Directory

Overview:

Service Provider Directory



ARIZONA
TELEMEDICINE
PROGRAM



telemedicine.arizona.edu



- Home
- Blog
- About Us
- Distance Education
- Applications & Network
- Resources

- Educational Events
- Grand Rounds
- Training
- Previous Webinars
- Upcoming Webinars
- Project ECHO
- Video Streaming - UAHS

Telem

Blog



Reimagining the Future of Telemedicine in a Post-COVID World

Apr 21, 2021 11:00am to 1:00pm MST



Tele-Dentistry - The State of The Union

Evaluation of the Nurtured Heart Approach To Parenting to Improve Attention and Hyperactivity/Impulsivity in Children (Webinar)
Apr 21, 2021 2:00pm to 3:00pm MST



Telemedicine in the UAE: A Case Study

Virtual Telehealth Office Hours
Guest: Farshad "Mazda" Shirazi, MD (Meeting)
Apr 28, 2021 12:00pm to 1:00pm MST

- View All Blog Posts
- Get Blog Updates

Virtual Telehealth Office Hours
Guest: Carol Yarbrough (Meeting)
May 19, 2021 12:00pm to 1:00pm MST

- Service Provider Directory
- ATP Service Desk
- Telemedicine Training
- AT Council
- Contact Us
- Southwest TRC

Get ATP/Blog Updates

Connect With Us



Subdivisions



- Home
- Blog
- About Us
- Distance Education
- Applications & Network
- Resources

Telemedicine COVID-19 Resources

Blog



Reimagining the Future of Telemedicine in a Post-COVID World



Tele-Dentistry - The State of The Union



Telemedicine in the UAE: A Case Study

- ▶ View All Blog Posts
- ▶ Get Blog Updates

Events

Telehealth Rehab is so much more than just video visits (Webinar)
 Apr 19, 2021 11:00am to 12:00pm MST



Arizona Telemedicine Council (Webinar)
 Apr 21, 2021 11:00am to 1:00pm MST



Evaluation of the Nurtured Heart Approach To Parenting to Improve Attention and Hyperactivity/Impulsivity in Children (Webinar)
 Apr 21, 2021 2:00pm to 3:00pm MST



Virtual Telehealth Office Hours
 Guest: Farshad "Mazda" Shirazi, MD (Meeting)
 Apr 28, 2021 12:00pm to 1:00pm MST



Virtual Telehealth Office Hours
 Guest: Carol Yarbrough (Meeting)
 May 19, 2021 12:00pm to 1:00pm MST



- Service Provider Directory
- Southwest TRC
- T-Health
- ATP Service Desk
- Telemedicine Training
- AT Council
- Contact Us
- Southwest TRC

Get ATP/Blog Updates

Connect With Us





search this site



Home About Us Region Blog Online Education Resources Events Training Contact Us

Events

Telehealth Rehab is so much more than just video visits Apr 19, 2021 11:00am to 12:00pm MST

Arizona Telemedicine Council Apr 21, 2021 11:00am to 1:00pm MST

Evaluation of the Nurtured Heart Approach To Parenting to Improve Attention and Hyperactivity/Impulsivity in Children Apr 21, 2021 2:00pm to 3:00pm MST

Virtual Telehealth Office Hours Guest: Farshad "Mazda" Shirazi, MD Apr 28, 2021 12:00pm to 1:00pm MST

Virtual Telehealth Office Hours Guest: Carol Yarbrough May 19, 2021 12:00pm to 1:00pm MST

Developing a Telemedicine Program (Webinar) May 24, 2021 9:00am to 2:00pm MST

DO THIS not That May 27, 2021 9:00am to 10:00am MST

Register / View All Events

Welcome to the Southwest TRC!

Telemedicine COVID-19 Resources

Grid of navigation buttons: Service Provider Directory, Events, On-Line Library, Resources, Blog, Contact Us

SWTRC Blogs

Teledentistry - Lights. Camera. Open Wide.



Where a person lives shouldn't dictate the quality of their care



Can we provide care across state lines?



All Blogs

Get SWTRC Updates

Email Address

Email input field

Subscribe

SWTRC is a proud member of:



View the NCTRC White Paper and Annual Report

For assistance, please use our 'Contact Us' form.

Subdivisions



- Home
- Blog
- About Us
- Distance Education
- Applications & Network
- Resources

Telemedicine COVID-19 Resources

Blog



Reimagining the Future of Telemedicine in a Post-COVID World



Tele-Dentistry - The State of The Union



Telemedicine in the UAE: A Case Study

- ▶ View All Blog Posts
- ▶ Get Blog Updates

Events

Telehealth Rehab is so much more than just video visits (Webinar)
 Apr 19, 2021 11:00am to 12:00pm MST



Arizona Telemedicine Council (Webinar)
 Apr 21, 2021 11:00am to 1:00pm MST



Evaluation of the Nurtured Heart Approach To Parenting to Improve Attention and Hyperactivity/Impulsivity in Children (Webinar)
 Apr 21, 2021 2:00pm to 3:00pm MST



Virtual Telehealth Office Hours
 Guest: Farshad "Mazda" Shirazi, MD (Meeting)
 Apr 28, 2021 12:00pm to 1:00pm MST



Virtual Telehealth Office Hours
 Guest: Carol Yarbrough (Meeting)
 May 19, 2021 12:00pm to 1:00pm MST



- Service Provider Directory
- Southwest TRC
- T-Health
- ATP Service Desk
- Telemedicine Training
- AT Council
- Contact Us
- Southwest TRC

Get ATP/Blog Updates

Connect With Us



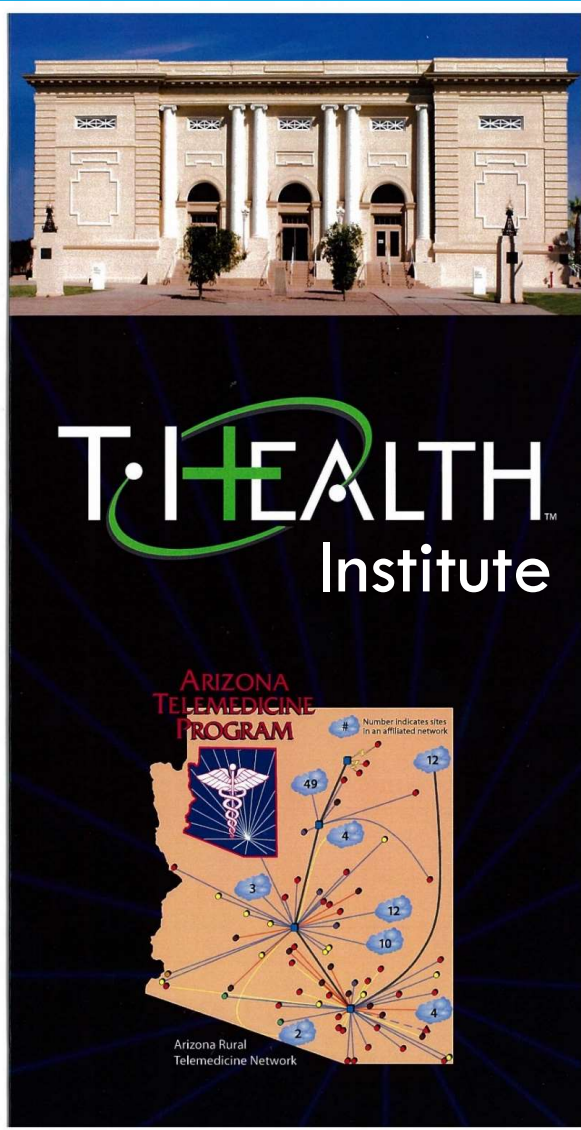



ARIZONA
TELEMEDICINE
PROGRAM



[Home](#) [Blog](#) [About Us](#) [Distance Education](#) [Applications & Network](#)

[Home](#) » [Resources](#) » [T-Health Institute](#)

T-Health Institute



Ronald S. Weinstein, M.D.
Executive Director,
T-Health Institute
rweinstein@telemedicine.arizona.edu



Chris Martin
T-Health Institute
Assistant Director
cmartin@telemedicine.arizona.edu

Featured: Medical Science Education Innovation

Ronald S. Weinstein, MD, Unveils Flexner 3.0 Medical Science Curriculum at Johns Hopkins School of Medicine

"Flexner 3.0," Dr. Weinstein's latest invention, recalibrates health science education for the United States by repositioning "introduction to medical science coursework" from medical schools into K-12 schools. His Flexner 3.0 program also calls for reducing high school education by two years, and college and medical schools' by one year each. Dr. Weinstein states, "It was an honor to be invited to introduce the Flexner 3.0 curricular model at Johns Hopkins School of Medicine, the institution that pioneered our current standard model for medical education. [Click here](#) to see more information about Flexner 3.0.

Downtown
Phoenix, AZ



T-HEALTH Institute

"e-Classroom of the future"

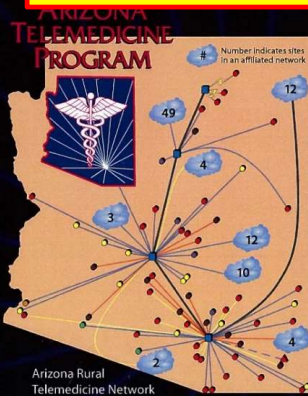

T-Health Amphitheater in use for Arizona Telemedicine Program training



Visible Social Networking Platforms



These illustrations show iconic representations of stacks of medical students (upper left), nursing students (upper right), pharmacy students (lower left), and public health students (lower right). **Top Row:** diagrammatic representation of four layers of the stacks. **Bottom Row:** diagrammatic representation of "exploded" version of the electronic stacks of students. **Below:** Students can take portable "in a suitcase" video conferencing units (i.e., Tandberg T-150) with them for off-campus rural rotations, and then link themselves back into the T-Health Amphitheater in Phoenix by broadband Internet.

"e-Swaps" **NEW**

Graphic representation of T-Health Amphitheater 2 x 6 video cube wall. These schematic illustrations show how two e-groups in quads, i.e., a group of four medical students on the left, and four nursing students on the right (top figure), can be electronically reconfigured and reconstituted into interprofessional teams "on the fly." The students can be either on-campus or off-campus. The result is an admixture of medical students and nursing students in the two individual learning

"innovative video-based social networking tools"

working in single profession groups vs. multi-profession teams.

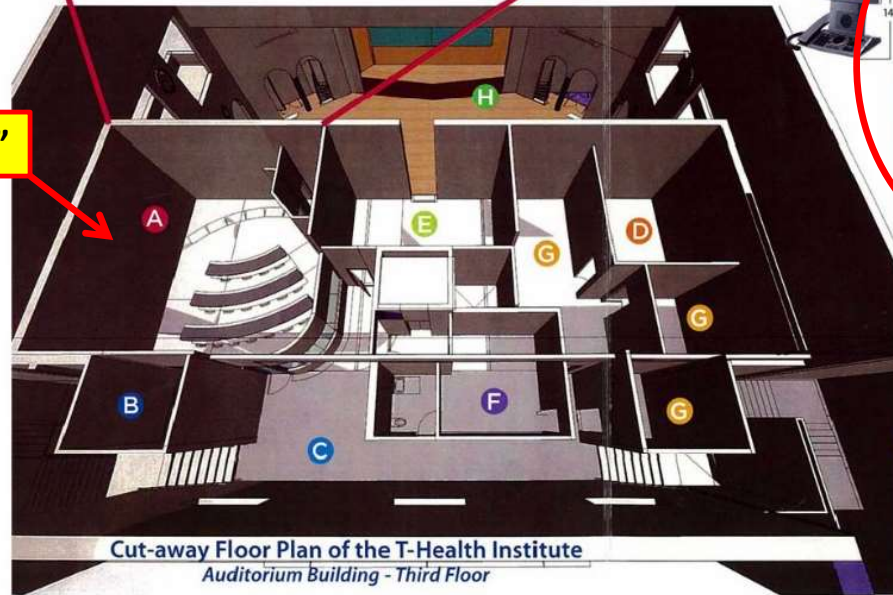

- FLOOR PLAN LEGEND**
- A - T-Health Amphitheater
 - B - Amphitheater Control Room
 - C - Observation Deck
 - D - Telemedicine Training Suite
 - E - Campus Control Room
 - F - Video Conference Room
 - G - Staff Offices
 - H - Auditorium

Phoenix Union Bioscience High School in Phoenix, Arizona



Downtown
Phoenix, AZ



***Downtown
Phoenix, AZ***



Downtown
Phoenix, AZ

Omnibus Pathology Course (OPC)

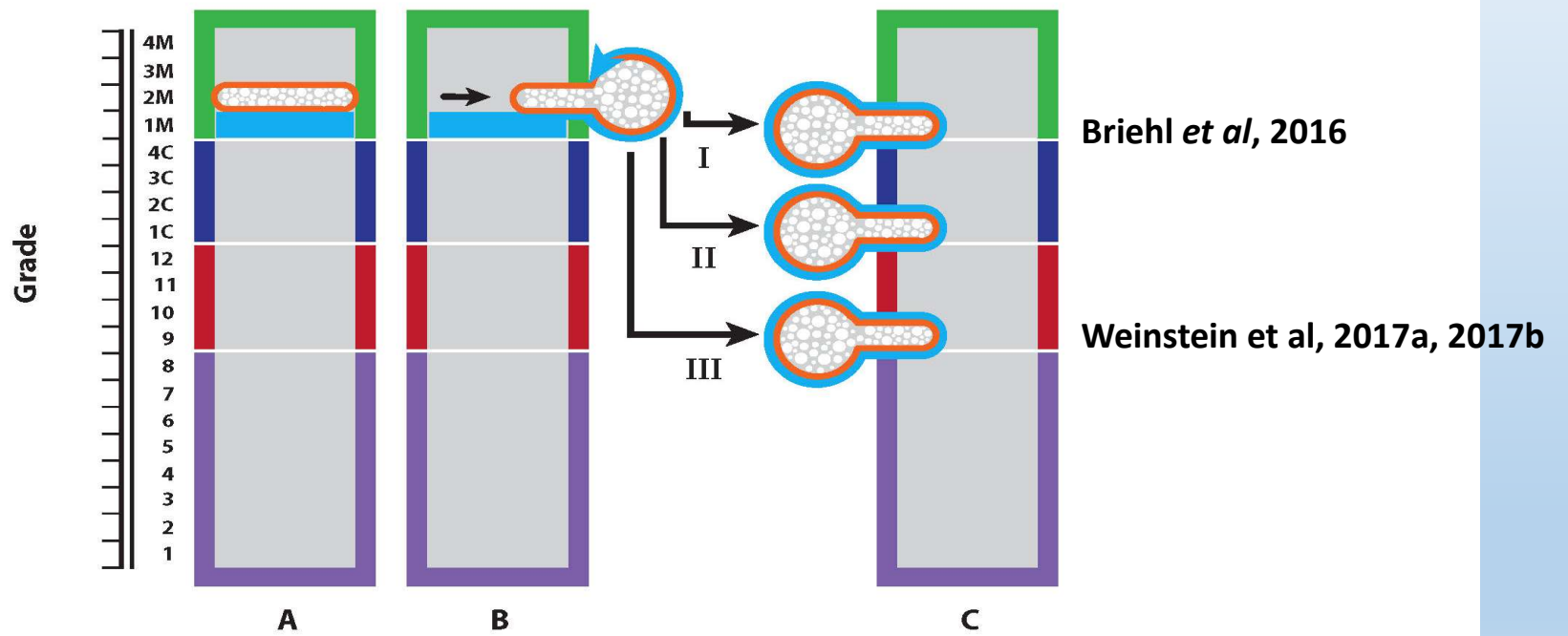



Sir William Osler



T-Health Amphitheater



T-Health Institute – Innovations in Medical Science Education



***Downtown
Phoenix, AZ***



“Reinventing Medical Science and Population Health Literacy Education
for the Second Flexner Century” (2010-2120)



Quick Tour of the ATP's Web Pages

Private Tours Available Upon Request

Ronald S. Weinstein, MD, FCAP, FATA
Director, Arizona Telemedicine Program

